

平面図

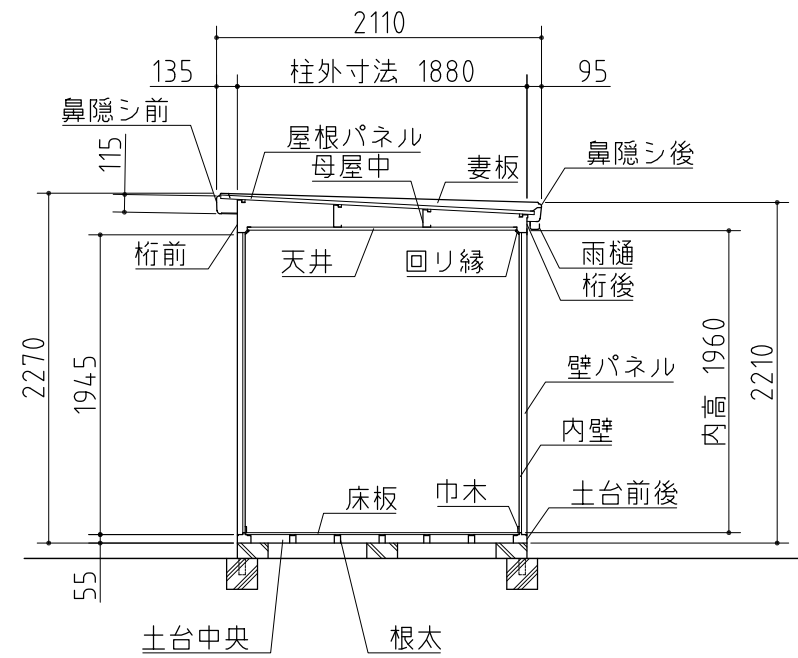

断面図

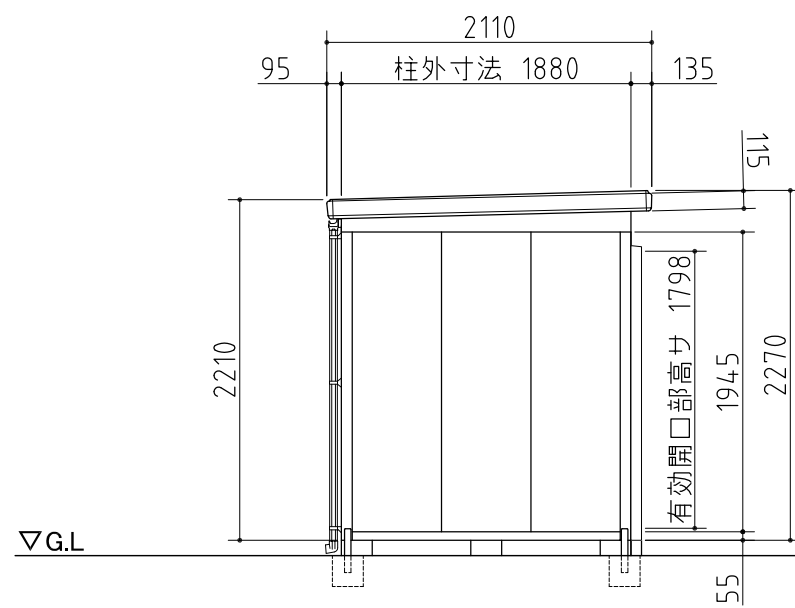

左側面図

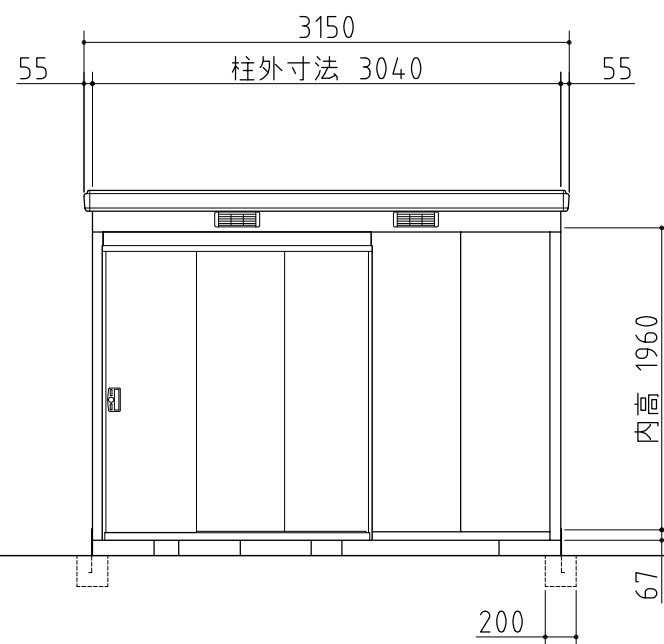

正面図

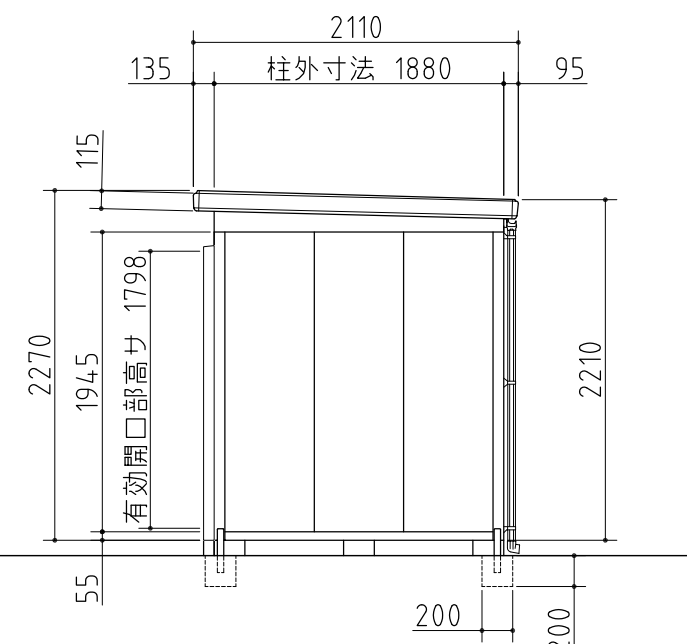

右側面図

外形図

<縮尺> S=1/50  
~一般型・多雪地型~

機種名 SMK-58SN

- 扉部有効開口寸法: 1090×1798 (mm)
- 床面積: 5.72㎡(1.73坪)